

Intelligent Hybrid System



## Multiline Telephone User Guide

Nothing contained in this manual shall be deemed to be, and this manual does not constitute, a warranty of, or representation with respect to, any of the equipment covered. This manual is subject to change without notice and NEC Business Solutions Ltd has no obligation to provide any updates or corrections to this manual. Further, NEC Business Solutions Ltd also reserves the right, without prior notice, to make changes in equipment design or components as it deems appropriate. No representation is made that this manual is complete or accurate in all respects and NEC Business Solutions Ltd shall not be liable for any errors or omissions. In no event shall NEC Business Solutions Ltd be liable for any incidental or consequential damages in connection with the use of this manual. This document contains proprietary information that is protected by copyright. All rights are reserved. No part of this document may be photocopied or reproduced without prior written consent of NEC Business Solutions Ltd.

Copyright © 2004 by NEC Business Solutions Ltd  
All Rights Reserved.

## Before using Your Telephone...

Thank you for purchasing the NEC "Xen Topaz" system.

Due to the flexibility built into the system, your **Dialling Codes and Feature Capacities** may differ from those in this guide. Check with your Supplier / System Administrator and make a note of any differences.

## Using Your Multiline Telephone...

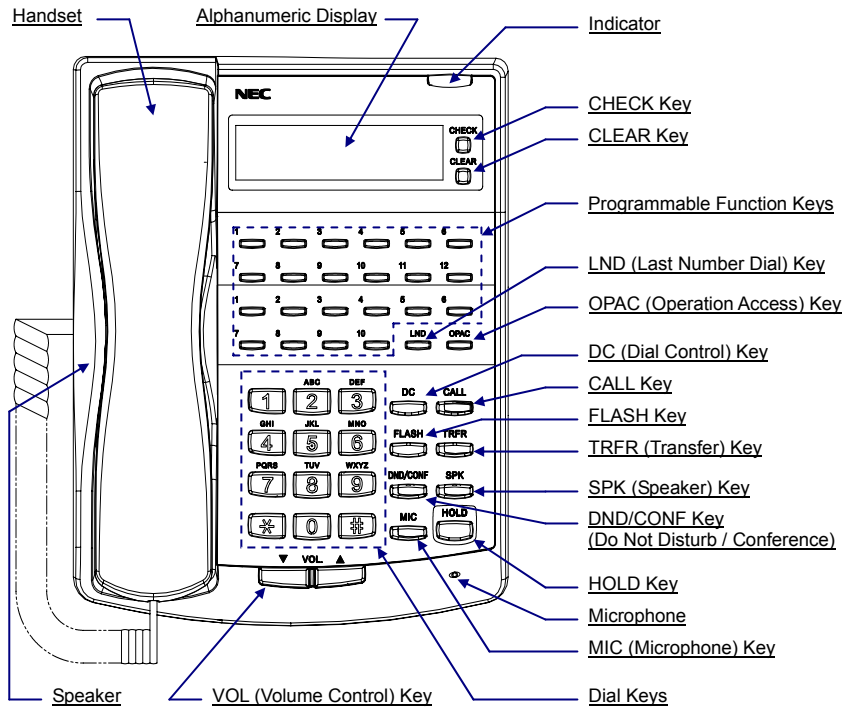

Functions	12TXD	12TD	6TXD	6TD
Programmable Keys	12	12	6	6
Additional Prg. Keys	10	10	10	10
Display	Yes	No	Yes	No
CHECK/CLEAR Keys	Yes	No	Yes	No
Handsfree	Yes	No (Talkback)	Yes	No (Talkback)
Accept DLS Console	Yes	No	Yes	No
Wall Mount Kit	Yes (Built-in)	Yes (Built-in)	Yes (Built-in)	Yes (Built-in)

### Handsfree Options

- Handsfree lets you place and answer calls by pressing "SPK" instead of using the handset.
- With Automatic Handsfree, you can press the CALL Key without lifting the handset. Normally, you have Automatic Handsfree.
- Use Handsfree Answerback to answer a voice-announced Intercom call by speaking toward your phone without lifting the handset.

## For more convenient use...

### Do Not Disturb (DND)

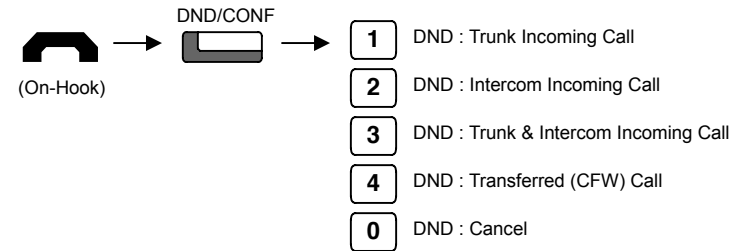

◆ When you set DND, the DND/CONF Key's lamp is lit and the Internal Dial Tone pattern changes.

### Call Forward / Follow Me

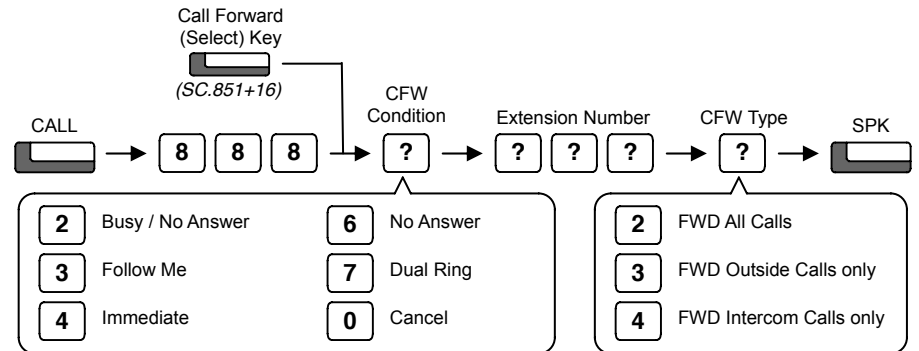

- ◆ When you set a Call Forward, the DND/CONF Key's lamp flashes and Internal Dial Tone pattern changes.
- ◆ When using a Call Forward (Select) Key, press the key and wait to cancel a Call Forward setting, then press the key and wait again to restore the previous Call Forward setting.

### Call Forward Off-Premise

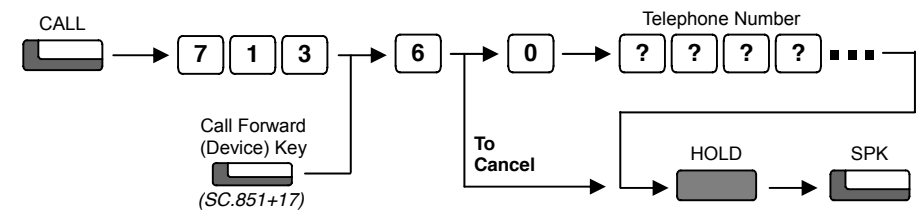

◆ When you set a Call Forward, the DND/CONF Key's lamp flashes and the Internal Dial Tone pattern changes.

## Hold / Transferring Calls

### Placing a Call on Hold / Retrieving a Held Call

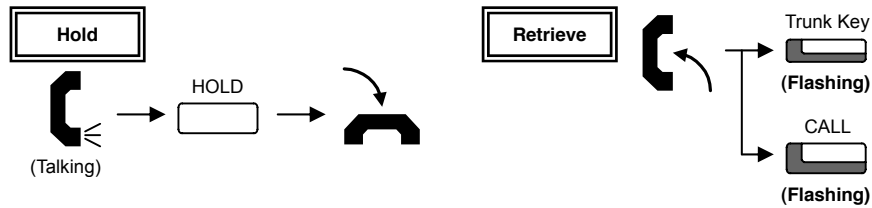

- ◆ When an Intercom call is placed on hold, the call is held as "Exclusive Hold" on your phone.
- ◆ While your outside call is on System Hold, other extension users can take the call off Hold.

### Placing a Call on Exclusive Hold

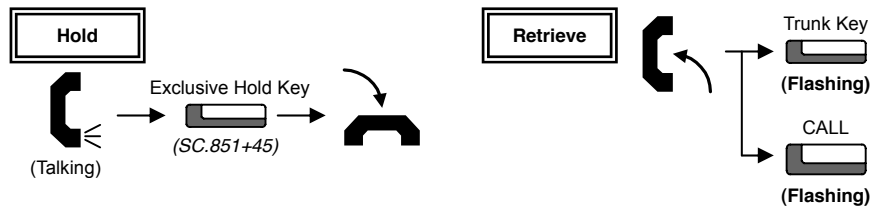

- ◆ System programming is required to use Exclusive Hold. Ask your NEC Authorised Supplier for details.
- ◆ While your outside call is on Exclusive Hold, other extension users can not take the call off Hold.

### Retrieving a Held Outside Call (if your extension doesn't have trunk keys)

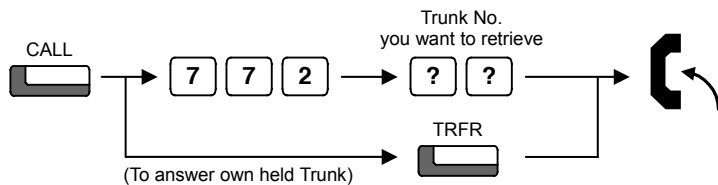

### Transferring a Call to another Extension

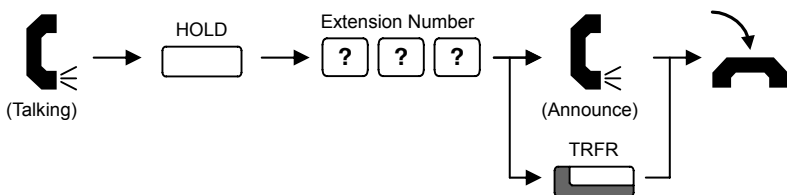

- ◆ If your phone has a DSS or One-Touch Key for the extension user who is to receive the call, just press it instead of "HOLD + Extension Number" in the operation above.

## For Your Convenience

### Programming a Function Key

Programmable Function Keys can be assigned as Appearance Keys (e.g. Trunks) or General Keys (e.g. DSS/One-Touch). Press the Function Key to activate the assigned function without dialling the Service Code.

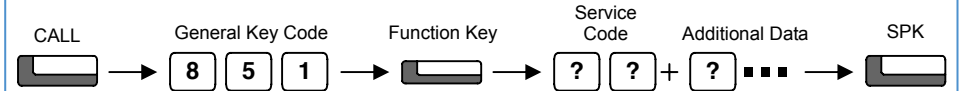

- ◆ An existing Appearance Key cannot be overwritten without the Appearance Key first being erased.
- ◆ Programmable Function Keys (General Key Code) can be erased by entering Service Code 00.

#### Common Service Codes:

01	DSS/One-Touch Key	10	Call Forward – Immediate
03	DND Key	11	Call Forward – Busy
04	Background Music (ON/OFF)	12	Call Forward – No Answer
05	Headset Key	13	Call Forward – Busy/No Answer
08	Incoming Caller ID List	14	Call Forward – Dual Ring
19	External Zone Paging	15	Call Forward – Follow Me
20	External All Call Paging	16	Call Forward – Select Option
21	Internal Zone Paging	17	Call Forward – Device
22	Internal All Call Paging	29	Repeat Redial
27	Abbreviated Dial – Common/Personal	30	Saved Number Redial
28	Abbreviated Dial – Group	31	Memo Dial

### Programming a DSS/One-Touch Key

Programmable Function Keys can be assigned as DSS (Direct Station Selection) or One-Touch Keys. You can place an Outside or Intercom call by pressing this key without dialling the number.

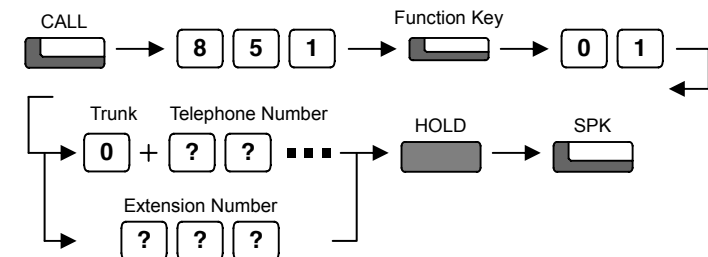

- ◆ Function Keys with one or two colour LEDs programmed as DSS keys will provide extension status indication, Idle=Off, Busy=lit. This is known as Busy Lamp Field (BLF) indication.
- ◆ When storing an outside telephone number, the Trunk Access Code (normally 0) must be added to the start of the number. Up to 36 digits can be stored.
- ◆ To program another key, press the next Programmable Function Key instead of the SPK Key to finish.

# For Your Convenience

## Programming Abbreviated Dialling Bins

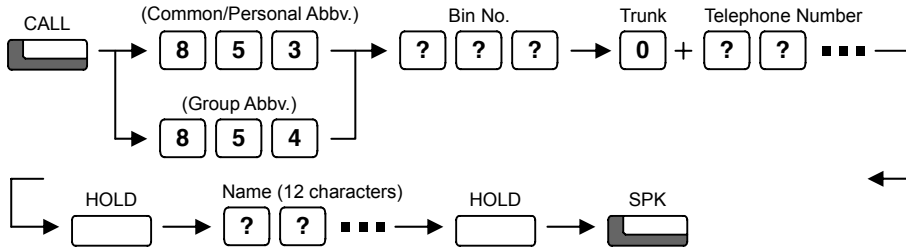

- ◆ Common/Personal Abbreviated Dialling Bins are numbered as follows (by default):  
2-digit dialling: Common = 00-79, Personal = 80-99, or  
3-digit dialling: Common = 000-899, Personal = 990-919.
- ◆ System programming is required to allow Group Abbreviated Dialling. Ask your NEC Authorised Supplier.
- ◆ Up to 36 digits dialling can be stored in each abbreviated dialling bin.
- ◆ To clear an abbreviated dialling bin (number & name), press the "CLEAR" key after dialling the Bin No..
- ◆ Applicable to Topaz Display Phones only.

## Entering a Name into an Abbreviated Dialling Bin

When entering a name, use the Dial Pad Keys on your telephone to enter letters as shown below. For example, press the "2" key once for "A", twice for "B", etc...

	Number of Key Presses												
	1	2	3	4	5	6	7	8	9	10	11	12	13
1	1	@	[	¥	]	^	_	'	{	}	→	←	
2	A	B	C	a	b	c	2						
3	D	E	F	d	e	f	3						
4	G	H	I	g	h	i	4						
5	J	K	L	j	k	l	5						
6	M	N	O	m	n	o	6						
7	P	Q	R	S	p	q	r	s	7				
8	T	U	V	t	u	v	8						
9	W	X	Y	Z	w	x	y	z	9				
0	0	!	"	#	\$	%	&	'	(	)			
*	*	+	,	-	.	/	:	;	<	=	>	?	

# Accepts a character and move the cursor one place to the right. Press twice to insert a "space".

DND/CONF Clear the character entry to the left, one character at a time (Backspace Key).

# Answering Calls

## Answering an Outside Call

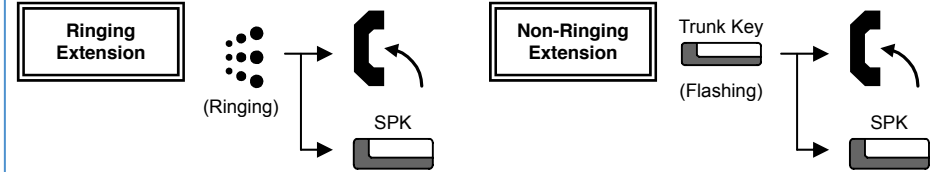

- ◆ Confirm status of the MIC Key if you want to answer Handsfree [MIC On = Light On, MIC Off = Light Off]. (Topaz Display Phones Only)

## Answering an Intercom Call

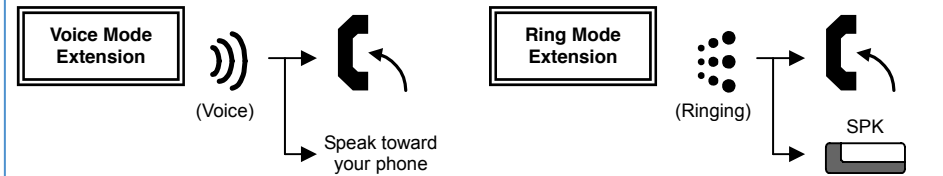

- ◆ Intercom Call Mode can be set at your phone as follows: "Ring" = CALL + 823, "Voice" = CALL + 821.
- ◆ Confirm status of the MIC Key if you want to answer Handsfree [MIC On = Light On, MIC Off = Light Off].

## Picking up another Extension's Call

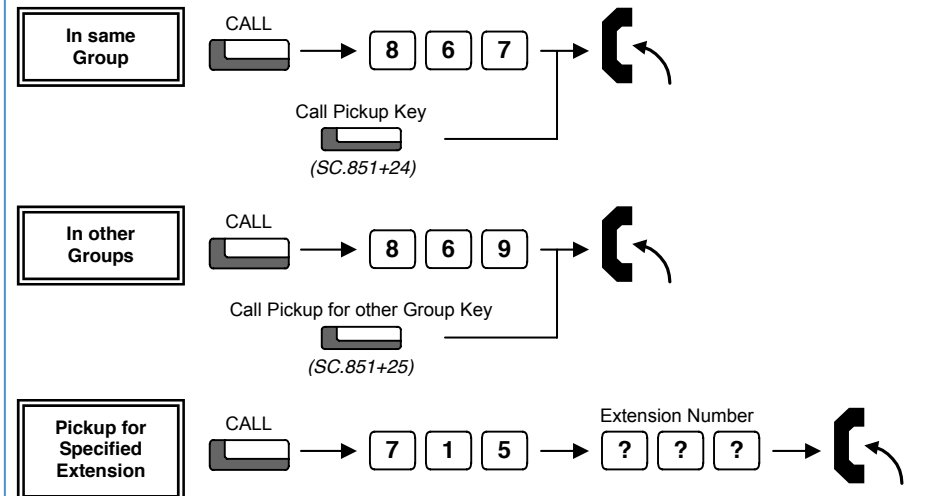

- ◆ System programming is required to allow Group Call Pickup. Ask your NEC Authorised Supplier for details.

## If your call doesn't go through...

### Checking & Answering a Message Waiting Indication

You can check who left a message waiting indication for you, and then answer.

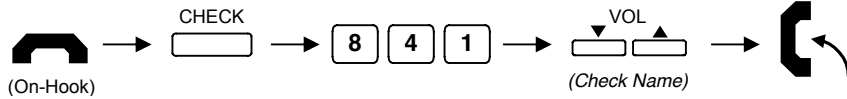

- ◆ Applicable to Topaz Display Telephones only.

### Cancelling a Message Waiting Indication (at originating extension)

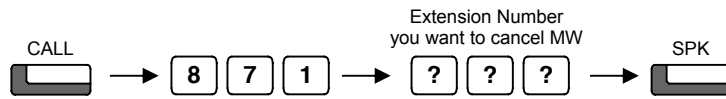

### Clearing All Message Waiting Indications (at any extension)



- ◆ Clears all messages you have left for other extensions and messages other extension have left for you.

### Repeat Dialling <Outside Call>

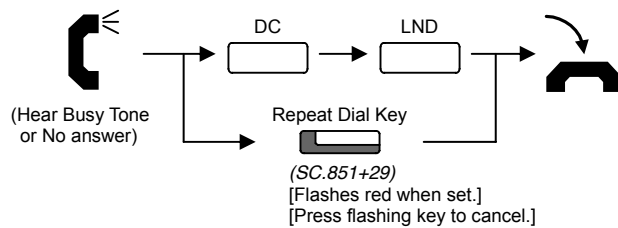

- ◆ The system periodically redials the call. Repeat duration is programmable. Ask your NEC Authorised Supplier for details.
- ◆ You should lift the handset when the called party answered.
- ◆ You can cancel this function by pressing "DC" and "LND" during idle condition.
- ◆ Does not reserve line. Will select other available line when original line is in use.

## Placing Calls

### Placing an Outside Call <Quick Access>

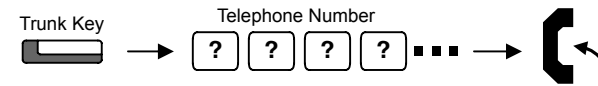

- ◆ Listen for Dial Tone before dialling a Telephone Number.
- ◆ You can have function keys for Trunks or Trunk Groups. Ask your Supplier.

### Placing an Outside Call <Access Code>

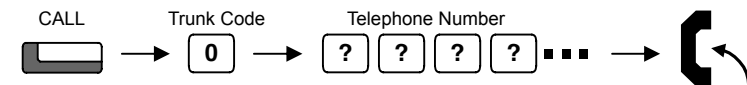

- ◆ Listen for Dial Tone before dialling the Telephone Number.

### Placing an Intercom Call <Dial Access>

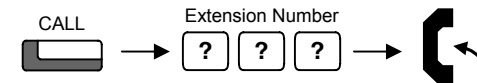

- ◆ Pressing CALL key after dialling an extension number is also possible.
- ◆ Your call will ring or voice-announce. If you hear ringing, wait for an answer. If you hear a beep, begin speaking. Dialling "1" changes voice/ring mode (where the destination is a Topaz Telephone).

## Placing Calls Quickly

### Using Abbreviated Dialling <Outside Calls>

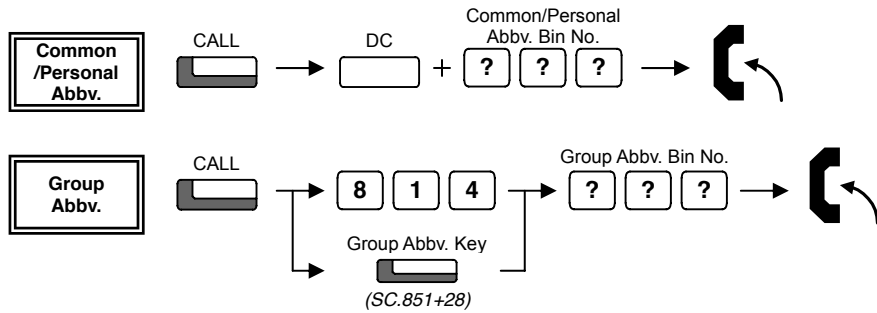

- ◆ Common/Personal Abbreviated Dialling Bins are numbered as follows (by default):  
2-digit dialling: Common = 00-79, Personal = 80-99, or  
3-digit dialling: Common = 000-899, Personal = 990-919.
- ◆ System programming is required to provide Group Abbreviated Dialling. Ask your NEC Authorised Supplier for details.

### Using One-Touch Keys <Outside/Intercom Calls>

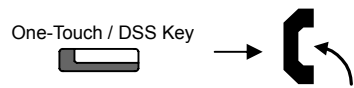

- ◆ The Telephone / Extension Number shall be pre-registered to a One-Touch / DSS Key (refer to Page 2).
- ◆ Trunk Access Code (Dial "0") should be added as the first digit of the Telephone Number.

### Last Number Redial < Outside/Intercom Calls>

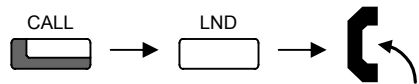

**Redial List** The system retains the last 10 numbers dialled which can be viewed and dialled. (Topaz Display Phones Only)



- ◆ Intercom numbers can also be stored under Last Number Redial. Ask your NEC Authorised Supplier for details.

## If your call doesn't go through...

### Setting Camp On / Callback / Trunk Queuing

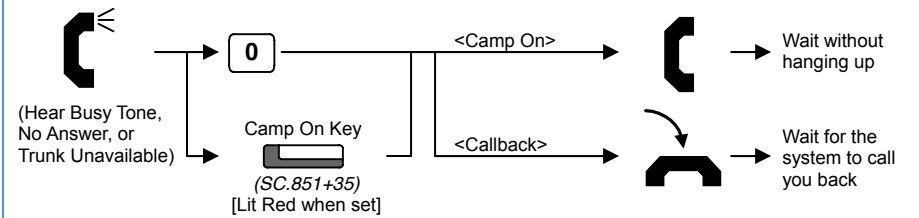

- ◆ <Camp On> For Intercom Call, when you hear ringing, wait for the called party to answer. For Trunk Queuing, when you hear Dial Tone, begin dialling the telephone number.
- ◆ <Callback> For Intercom Call, when your phone starts the ringing, lift handset and wait for the called party to answer. For Trunk Queuing, when your phone starts the ringing, lift handset, hear Dial Tone and begin dialling the telephone number.

### Cancelling Camp On / Callback / Trunk Queuing

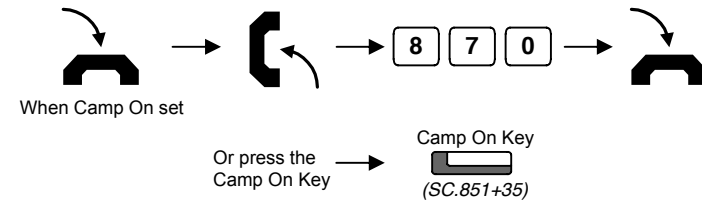

### Set / Answer a Message Waiting

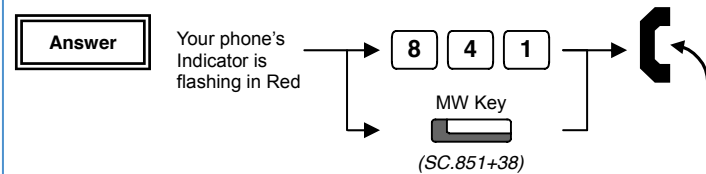
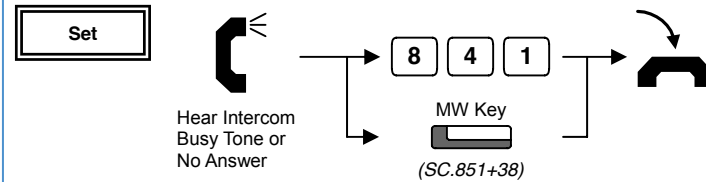

- ◆ When you set a MW, the called party's MW Indicator starts to flash, and your MW Indicator is lit Red.
- ◆ When you answer a MW, the MW Indicator will automatically go off when the called party answers.